

SHARP

AQUOS

LED BACKLIGHT TV

USER MANUAL



2T-C32GH3000X 2T-C43GH3000X

To obtain the best performance and safety, please read this manual carefully.
Please keep this manual for future reference.

Content

Content	2
Preparation.....	3
Warnings and Precautions.....	4
Terminal Connection.....	8
Remote Control.....	9
Smart Features.....	10
Basic Features.....	11
User Settings.....	13-18
Initial Setup.....	13
Source Menu.....	14
TV Menu.....	14
Dashboard Menu.....	15
Main Menu.....	15
Media Player.....	19
Troubleshooting.....	21
Specifications.....	22
Licenses.....	24
End User License Agreement	25-28

Note:

- 1. The pictures in this manual are only for references.*
- 2. Design and specifications are subject to change without notice.*
- 3. In dry environment due to static electricity, the product may restart and return to the main OSD interface, USB player interface or the previous source mode. It is normal and please continue to operate the TV.*

Preparation

Unpacking and Installation

Note: The pictures are only for reference.

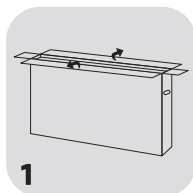

Open the package.



Take out the TV.

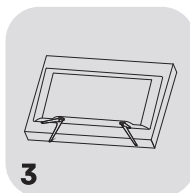

Install the TV stands.

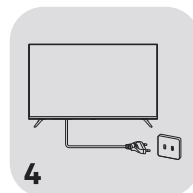

Connect the power cord.

Standard Accessories

Note: The pictures are only for reference.

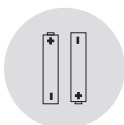

Batteries/2



Remote Control

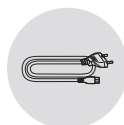

AC Power Cord

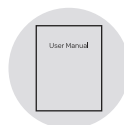

User Manual

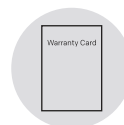

Warranty Card



For 2T-C32GH3000X,
Stand Base x2

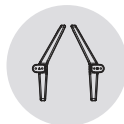

For 2T-C43GH3000X,
Stand Base x2



Stand Screws
2T-C32GH3000X : 2pcs
2T-C43GH3000X : 4pcs

Stand Installation

Note: The pictures are only for reference.

Step 1: Take out the TV and carefully put it (screen downward) on a stable and flat table with a soft cloth or cushion on it.

Step 2: Please check to make sure there is the same mark (A/B) on the TV back and the correct stand base. This step is not available for the bases without any mark on them, or not available for the TV with one stand base only.

Step 3: Fix the stand bases to the TV by fastening the matching stand screws provided in the box. The bases may vary depending on the region or model.

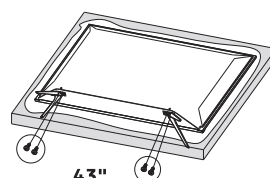
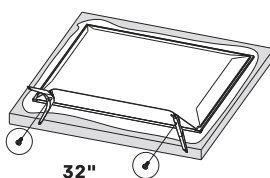
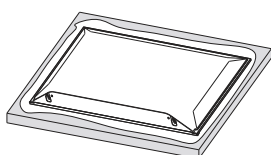

Warnings and Precautions

Read all of the instructions before operating the set. Keep these instructions well for later use.

Important Safety Instructions

- Read these instructions – All the safety and operating instructions should be read before this product is operated.
 - Keep these instructions – The safety and operating instructions should be retained for future reference.
 - Heed all warnings – All warnings on the appliance and in the operating instructions should be adhered to.
 - Follow all instructions – All operating and use instructions should be followed.
 - Do not use this apparatus near water – The appliance should not be used near water or moisture – for example, in a wet basement or near a swimming pool, and the like.
 - Clean only with dry cloth.
 - Do not block any ventilation openings. Install in accordance with the manufacturer's instructions.
 - Do not install near any heat sources such as radiators, heat registers, stoves, or other apparatus (including amplifiers) that produce heat.
 - Do not defeat the safety purpose of the polarized or grounding plug. A polarized plug has two blades with one wider than the other. A grounding plug has two blades and a third grounding prong. The wide blade or the third prong is provided for your safety. If the provided plug does not fit into your outlet, consult an electrician for replacement of the obsolete outlet.
 - Protect the power cord from being walked on or pinched particularly at the plugs, convenience receptacles, and at the point where they exit from the apparatus. Only use attachments/accessories specified by the manufacturer.
 - Use only with the cart, stand, tripod, bracket, or table specified by the manufacturer, or sold with the apparatus. When a cart or rack is used, use caution when moving the cart/apparatus combination to avoid injury from tip-over.
 - Unplug the apparatus during lightning storms or when unused for long periods of time.
 - Refer all servicing to qualified personnel. Servicing is required when the apparatus has been damaged in any way, such as power supply cord or plug is damaged, liquid has been spilled or objects have fallen into the apparatus, the apparatus has been exposed to rain or moisture, does not operate normally, or has been dropped.
- CAUTION: These servicing instructions are for use by qualified service personnel only. To reduce the risk of electric shock, do not perform any servicing other than that contained in the operating instructions unless you are qualified to do so.
 - Do not install this equipment in a confined or building-in space such as a book case or similar unit, and remain a well ventilation conditions at open site. The ventilation should not be impeded by covering the ventilation openings with items such as newspaper, table-cloths, curtains etc.
 - Please refer the information on rear enclosure for electrical and safety information before installing or operating the apparatus.
 - To reduce the risk of fire or electric shock, do not expose this apparatus to rain or moisture.
 - The apparatus shall not be exposed to dripping or splashing and that no objects filled with liquids, such as vases, shall be placed on the apparatus.
 - For the terminals marked with symbol of “ $\frac{1}{4}$ ” may be of sufficient magnitude to constitute a risk of electric shock. The external wiring connected to the terminals requires installation by an instructed person or the used of ready-made leads or cords.
 - To prevent injury, use the stand/wall-mount bracket to securely install this apparatus on the table/wall in accordance with the installation instructions.
 - Danger of explosion if battery is incorrectly replaced. Replace only with the same or equivalent type.
 - The battery (battery or batteries or battery pack) shall not be exposed to excessive heat such as sunshine, fire or the like.
 - Excessive sound pressure from earphones and headphones can cause hearing loss. Listening to music at high volume levels and for extended durations can damage one's hearing. In order to reduce the risk of damage to hearing, one should lower the volume to a safe, comfortable level, and reduce the amount of time listening at high levels.
 - The appliance coupler is used as disconnect device, the disconnect device shall remain readily operable.
 - When not in use and during movement, please take care of the power cordset, e.g. tie up the power cordset with cable tie or something like that. It shall be free from sharp edges and the like that can cause abrasion of the power cordset. When put into use again, please make sure the power cordset being not damaged. If any damages found, please look for the service person to replace the power cordset.

Warnings and Precautions

● Attention should be drawn to environmental aspects of battery disposal.

● No naked flame sources, such as lighted candles, should be placed on the apparatus. To prevent the spread of fire, keep candles or other open flames away from the apparatus at all times.

● If the apparatus have the symbol  in its rating label and the power cord has two pins, it means that the equipment is a Class II or double insulated electrical appliance. It has been designed in such a way that it does not require a safety connection to electrical earth. (Only for Class II appliance)

● The following information are recommended to be included as far as applicable where applicable:

~ Refers to alternating current (AC).

--- Refers to direct current (DC).

 Refers to Class II equipment.

 Refers to stand-by.

I Refers to power ON.

 Refers to dangerous voltage.

● Warning for Apparatus containing COIN / BUTTON CELL BATTERIES (Below instruction only used for the apparatus containing a user-replaceable coin/button cell battery)

WARNING:

Do not ingest the battery, Chemical Burn Hazard (The remote control supplied with) this product contains a coin/button cell battery. If the coin/button cell battery is swallowed, it can cause severe Internal burns in just 2 hours and can lead to death. Keep new and used batteries away from children.

If the battery compartment does not close securely, stop using the product and keep it away from children. If you think batteries might have been swallowed or placed inside any part of the body, seek immediate medical attention.

● WEEE Directive



Correct Disposal of this product. This marking indicates that this product should not be disposed with other household wastes throughout the EU. To prevent possible harm to the environment or human health from uncontrolled waste disposal, recycle it responsibly to promote the sustainable reuse of material resources. To return your used device, please use the return and collection systems or contact the retailer where the product was purchased. They can take this product for environmental safe recycling.



● This lightning flash with arrowhead symbol within an equilateral triangle is intended

to alert the user to the presence of non-insulated "dangerous voltage" within the product's enclosure that may be of sufficient magnitude to constitute a risk of electric shock.

● To reduce the risk of electric shock. Do not remove cover (or back). No user serviceable parts inside. Refer to qualified service personnel.

● The exclamation point within an equilateral triangle is intended to alert the user to the presence of important operating and maintenance instructions in the literature accompanying the appliance.

Positioning the TV

● Install Display on solid horizontal surface such as a table or desk. For ventilation, leave a space of at least 10cm free all around the set. To prevent any fault and unsafe situations, please do not place any objects on top of the set.

Fixing the rear of enclosure to wall (only for some countries). The following picture is only for reference.

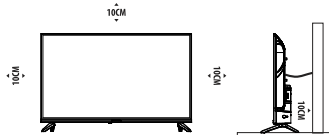

● Warning: Stability Hazard

A TV set may fall, causing serious personal injury or death. Many injuries, particularly to children, can be avoided by taking simple precautions such as:

- ALWAYS use cabinets or stands or mounting methods recommended by the manufacturer of the TV set.
- ALWAYS use furniture that can safely support the TV set.
- ALWAYS ensure the TV set is not overhanging the edge of the supporting furniture.
- ALWAYS educate children about the dangers of climbing on furniture to reach the TV set or its controls.
- ALWAYS route cords and cables connected to your TV so they cannot be tripped over, pulled or grabbed.
- NEVER place a TV set in an unstable location.
- NEVER place the TV set on tall furniture (for example, cupboards or bookcases) without anchoring both the furniture and the TV set to a suitable support.

Warnings and Precautions

- NEVER place the TV set on cloth or other materials that may be located between the TV set and supporting furniture.
- NEVER place items that might tempt children to climb, such as toys and remote controls, on the top of the TV or furniture on which the TV is placed.

If the existing TV set is being retained and relocated, the same considerations as above should be applied.

Mounting on a Wall

● An optional wall mount can be used with your TV. Consult with your local dealer to purchase the recommended wall mount bracket. Carefully attach the wall mount bracket at the rear of the TV. Install the wall mount bracket on a solid wall perpendicular to the floor. If you are attaching the TV to other building materials, please contact qualified personnel to install the wall mount. Detailed instructions will be included with the wall mount. Please use a wall mount bracket where the device is adequately secured to the wall with enough space to allow connectivity to external devices.

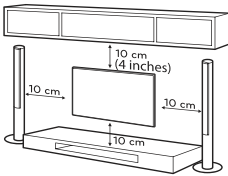

- To prevent product damages or personal injuries, please make sure that the TV screen is kept upright, or tilted upward or downward within the angle range of $0^{\circ}\sim 5^{\circ}$ while mounting the TV onto the wall.
- In case of exceeding the angle range ($0^{\circ}\sim 5^{\circ}$) of tilting downward, please purchase the auxiliary accessories from the local dealer to mount the TV for safe installation and usage. Otherwise, it will not be covered by the warranty and the user should be liable for all consequences and responsibilities.

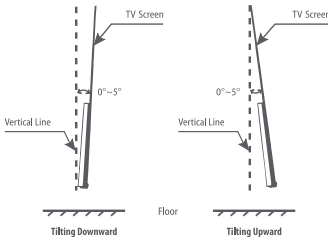

- Disconnect the power before moving or installing the TV. Otherwise electric shock may occur.
- Remove the stand before installing the TV on a wall mount by performing the stand attachment in reverse.
- If you install the TV on a ceiling or slanted wall, it may fall and result in severe injury. Use an authorized wall mount and contact the local dealer or qualified personnel. Otherwise it is not covered by the warranty.
- Do not over tighten the screws as this may cause damage to the TV and void your warranty.
- To prevent injury, this apparatus must be securely attached to the floor/wall in accordance with the installation instructions.
- Use the screws and wall mounts that meet the following specifications. Any damages or injuries by misuse or using an improper accessory are not covered by the warranty.
- It might be impossible to connect the cable to AV-IN depending on the form of VESA frame.

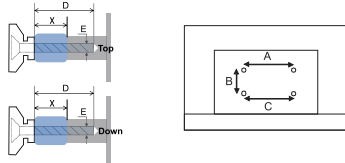

Model Size		32"		43"	
		Top	Down	Top	Down
Screw	Diameter(mm) "E"	M4	M4	M6	M6
	Depth(mm) "D"	Max 10+X	10+X	10+X	10+X
Spacer	Min	7+X	7+X	7+X	7+X
	Depth(mm) "X"	30	30	30	30
Screw Quantity		2	2	2	2
Spacer Quantity		2	2	2	2
A*B*C		200*100*200		200*100*200	

Warnings and Precautions

Note:

- 1) The pictures are for reference only.
- 2) For the TV sets with terminals facing towards the wall, in order to leave enough space to use the terminals, a rubber cushion is needed together with the screw to fix the wall mount. It is a small hollow pillar of which the height is $\geq 30\text{mm}$.

Operating Environment

- . Do not install this equipment in a confined space such as a bookcase or similar unit.
- . Do not use the set near damp, and cold areas, protect the set from overheating.
- . Keep away from direct sunlight.
- . Do not use the set near dust place.
- . Do not attach candle to accessible opening area, to avoid flammable foreign material from entering the TV.

Precautions for Using Remote Control

- . Use the remote control by pointing it towards the remote sensor. The items between the remote control and the remote sensor will interfere the normal operation.
- . Do not make remote control vibrate violently. Also, do not splash liquid on the remote control, also do not put the remote control in high humidity place.
- . Do not place remote control under direct sunlight which will cause deformation of the unit by heat.
- . When the remote sensor is under direct sunlight or strong lighting, the remote control will not work. If so please change the lighting or TV's position, or operate the remote control closer to the remote sensor.

Precautions for Using Battery

Improper using of the battery will cause leakage. So please do as the following methods and use carefully.

1. Please note the batteries' polarity, to avoid short circuit.
2. When the battery's voltage is insufficient which affect the use range, you should replace new battery. Remove the batteries from the remote control unit if you do not intend to use it for a long time.
3. Do not use different types of batteries (for example, Manganese and Alkaline batteries) together.
4. Do not put the battery into fire, and charge or decompose the battery.
5. Please dispose batteries abide by relevant environmental protection regulation.
6. WARNING: The batteries (battery pack or batteries installed) shall not be exposed to excessive heat such as sunshine, fire or the like.

Install Remote Control Battery

Place two AAA size batteries in the remote controls battery compartment, making sure to match the polarity markings inside the compartment.

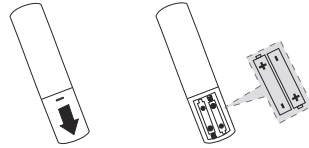

Note: The picture is only for reference.

TV Control Button

Note: The picture is only for reference.

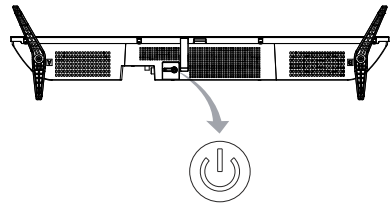

TV Control Button

- . Short press to display the menu. (Power, Source, Volume $-$, Volume $+$, etc.)
- . Short press to select the menu.
- . Long press to confirm the selected menu.

Terminal Connection

Note:

- 1) The pictures are only for reference.
- 2) External equipments and cables shown herein are not supplied with the TV.
- 3) Terminal names and quantities may vary depending on the region or model.

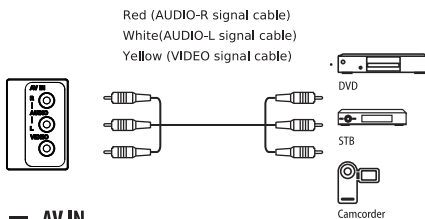
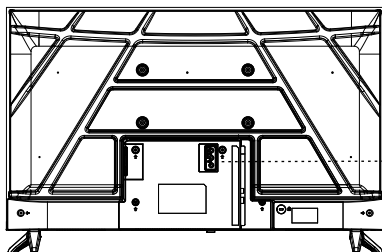

■ **AV IN**

Receive audio and video signal from external AV devices.

■ **DIGITAL AUDIO OUT**

Use an optical cable to output your TV audio signal to a compatible audio receiver.

■ **EARPHONE (🎧)**

Output the TV sound to the connected earphone. Speakers will be muted when headphone is plugged in.

■ **HDMI 1/2**

Receive HDMI input signal from external HDMI devices

Note:

When you need to connect a device which supports ARC function, select HDMI 2 interface

■ **ANTENNA IN**

Connect a coaxial cable to receive signal from the antenna, cable or satellite.

■ **LAN**

Wired network port.

■ **USB 1/2**

Connect a USB storage device.

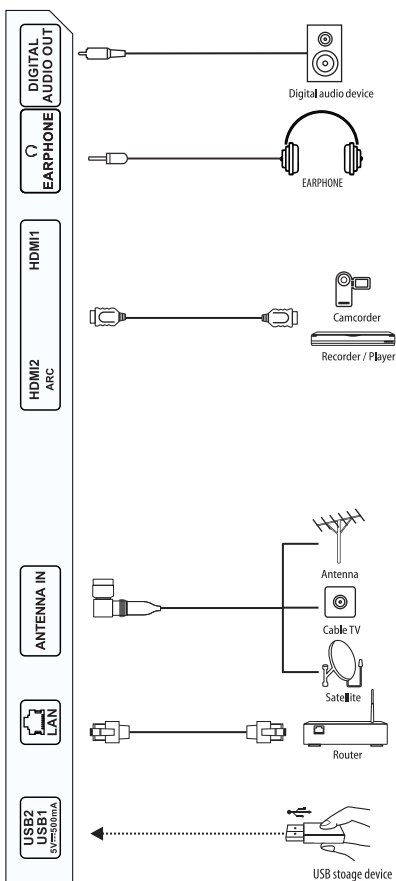







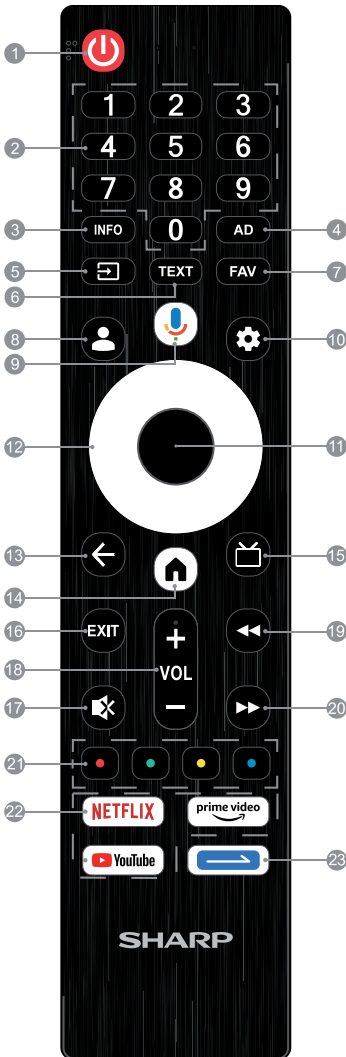





Remote Control

Note:

- 1). The picture is only for reference.
- 2). The image, buttons and functions of remote control may vary depending on the region or model.
- 3). The Bluetooth remote control can be paired with the TV easily and quickly by just pressing Google Assistant () button on any interface.



- 1. POWER** ()
Turn on the TV, or turn the TV to fastboot / standby mode.
- 2. NUMBER BUTTONS(0-9)**
Direct TV channel selection.
- 3. INFO**
Press once to view information about the programme you are currently watching. Press again to view detailed information. Press **▶** while the information panel is displayed to view information about the upcoming upcoming programme.
- 4. AD**
Turns the audio description function on or off.
- 5. SOURCE** ()
Access the source menu.
- 6. TEXT**
Turns teletext on/off.
- 7. FAV**
Opens the menu of favorites lists. Selecting one of the available favorites lists will also change how the OK button works. While watching live TV, after pressing OK, the last used favorite list will appear.
Note: If you later want to change the OK button function to the standard channel list, press OK to open the favorites list, then press the yellow button and select the channel list you wish to see after pressing OK.
- 8. PROFILE** ()
Sign in with your Google account to get the entertainment you love.
- 9. Google Assistant** ()
Start using the near field voice function.
• Short press this button to wake up the Google Assistant.
• Long press this button to start receiving your voice command. After your speaking, release this button to run voice function.
- 10. Dashboard** ()
Access the dashboard menu of your Google TV™.
- 11. OK**
Confirm, enter or execute the selected item, or access the channel list.
- 12. Navigation Buttons (UP/DOWN/LEFT/RIGHT)**
Navigate the menu to select the content you need, or press UP/DOWN button to change channels.
- 13. BACK** ()
Return to upper-level content, or exit the current screen or operation.
- 14. HOME** ()
Access the home screen.
- 15. EPG** ()
Access DTV or access the Electronic Program Guide in DTVmode.
- 16. EXIT**
Exit the currently displayed menu.
- 17. MUTE** ()
Mute or restore the TV sound.
- 18. Volume Up/Down (+/-)**
Adjust the sound volume.
- 19. FAST BACKWARD** ()
Playback in fast backward mode.
- 20. FAST FORWARD** ()
Playback in fast forward mode.
- 21. COLOUR buttons**
Execute corresponding function at that time.
- 22. Application Buttons**
Access specific applications quickly and directly.
- 23. Daily Key Button** ()
This button works as shortcut key for quick access to your favorite apps and functions. To start using this button function, long press to open the setting and select your favorite apps or functions. After setting, short press to access the apps and functions.

Smart Features

Home Screen

Press **HOME** (🏠) button to access the home screen as shown in the following picture.

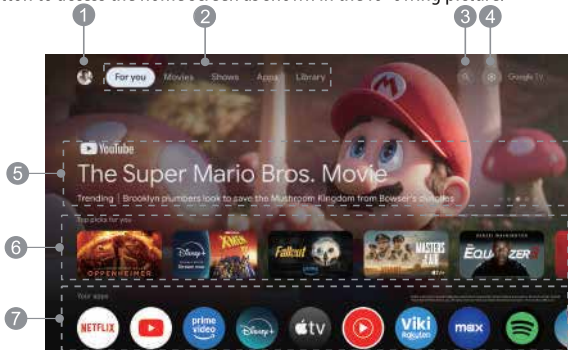

- 1. Account Center:** Add other family members' Google accounts, or setup and manage each Google account on your Google TV.
- 2. Navigation Bar:** Select to open tabs for various contents.
- 3. Search:** Search for movies, shows, apps and more.
- 4. Dashboard:** Access the dashboard menu of your Google TV.
- 5. Featured Carousel:** Display the hottest contents featured for you.
- 6. Top picks for you:** Highlight the best of recommendations from all content types.
- 7. Your apps:** Show the list of all pre-installed or user-installed applications on your Google TV.

Note:

- 1). The picture is only for reference.
- 2). Applications and contents on the home screen vary depending on the region or model. This manual doesn't include the operation instructions of all features on the home screen.
- 3). The browser may not support some web pages or videos due to network failure, difference of regions or service interruption, which has nothing to do with the TV.
- 4). If service providers upgrade or modify their servers, some applications may not be available on this TV.
- 5). Your remote control may not be compatible well with some network applications or fail due to service interruption, that has nothing to do with this TV.
- 6). For better experience, please connect and use the external mouse or keyboard when you access the internet browser or applications.
- 7). Some models support apk installation by the users, when using this feature, the users should ensure the correctness, security, compatibility and legality of the apk and should be responsible for any obligations thus resulted.
- 8). Some models support installing and using file manager application by the users, when using this feature, the users should not revise or delete a system file, otherwise will cause TV function problems and the customer should be responsible.
- 9). Network application contents and services are controlled by network application providers by means of networks and transmission facilities, which are subject to alteration, suspension, removal, termination or interruption, or invalid access at any time without further notice in that the manufacturer is unable to control or to be informed of the aforesaid change. The manufacturer makes a further declaration that it disclaims any responsibility or liability arising from customer's failure to use the network application contents and services caused by, including but not limited to, failure of network connection or communication lines, technological updates, or the alteration, suspension, interruption, termination, disabling, or removal of any contents or services by the network application providers etc.

Basic Features

Note: Colour buttons (**RED/GREEN/YELLOW/BLUE**) and play & pause buttons (▶ & ||) are listed in the virtual keyboard by pressing **SOURCE** (☐) button and selecting Virtual Keyboard from Shortcuts menu.

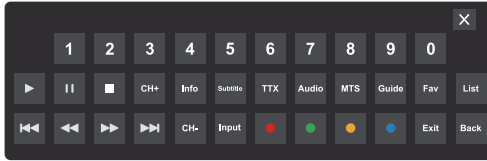

Note: The picture is only for reference.

Channel List

While watching programs in TV mode, press **OK** button to access the channel list.

1) In channel list:

- Press **RED** button in the virtual keyboard to manage channels.
- Press **GREEN** button in the virtual keyboard to operate channels.
- Press **YELLOW** button in the virtual keyboard to select another type of channel list, or access the favorite list.
- Press **BLUE** button in the virtual keyboard to add channels into the desired favorite list.

2) While playing favorite channels in the favorite list, you may only switch to play another favorite channel while pressing **UP/DOWN** button. If so, you can press **YELLOW** button in the virtual keyboard to select the type "All channels" when you want to watch all saved channels.

Electronic Program Guide





Note: The picture is only for reference.

Electronic Program Guide is supplied by the program providers and offers information about the programs to be broadcast. You can access it in DTV mode by pressing **EPG** (☐) button on the remote control.

- * Press **RED** button in the virtual keyboard to check the program information of previous day.
- * Press **GREEN** button in the virtual keyboard to check the program information of next day.
- * (May not be available) Press **YELLOW** button in the virtual keyboard to check more detailed information of the current program.
- * Press **BLUE** button in the virtual keyboard to select the desired program type.

Basic Features

Time-shift

Time-shift is used to record a DTV program when your viewing is interrupted or delayed. To enable or disable the Time-shift function, please select < **SOURCE** () button → Shortcuts → TV Menu → Record → Time Shift Mode > in DTV mode. After the Time-shift function has been enabled, press **Pause** () button in the virtual keyboard to pause playing the DTV program and start to record the program. Press **Play** () button in the virtual keyboard to continue playing the program from when you paused. Press **EXIT** button in the virtual keyboard to call out a prompt reminder, asking you whether or not to stop the time-shift function.

Note:

- 1) *Before time-shift, you'd better format your USB storage device to ensure there is enough space for time-shift recording. If you have any data saved on your USB storage device, please back up the data before formatting it. Formatting a USB storage device will erase all data saved on the USB storage device*
- 2) *The recorded program of time-shift will be cleared automatically after playing the program or stopping time-shift function.*
- 3) *If time-shift recording lasts too long, and there is no more space for recording new program, the TV will start to play the program automatically from the recording beginning to release the space of program which has been played for new program recording.*

User Settings

Initial Setup

When you turn on the TV for the first time, there will show a wizard to guide you to finish the following settings.

Step 1: Connect the Bluetooth® remote control.

Step 2: Select the menu language as you need.

Step 3: Select your region or country.

Step 4: Select to setup Google TV or setup basic TV. It is suggested that you select "Setup Google TV" to enjoy full smart features of your Google TV.

after setup google account

* TV will request automatic channel scan even if was done before. So, need to setup Google account before using TV functions.

*** For some countries, you can use your mobile phone or TV remote control to setup Google TV. If you prepare to setup the TV with your mobile phone, please operate according to on-screen instructions of both the TV and your phone. If you prepare to setup the TV with TV remote control, please select "Set up on TV instead"; and then go on with the following step. ***

Step 5: Connect your TV to the desired wireless network.

Step 6: Sign in with your Google account.

Step 7: Read to accept the Google terms of services and privacy policy.

Step 8: Read to accept the Google services settings.

Step 9: Learn the main feature of Google Assistant and select "Continue" to go to the next step.

Step 10: Select whether or not to let Google Assistant search across all your applications.

Step 11: Select to install the recommended applications from Google. This step may not be available depending on the Google service.

Step 12: Turn on or turn off the LCN (Logical Channel Number) switch.

Step 13: Setup the password for the parental lock system.

Step 14: Choose the TV usage environment between "Home" and "Shop". "Home" mode is recommended for normal home viewing, while "Shop" mode is used to demonstrate the TV in a shop and the like. It will consume more energy in "Shop" mode.

Step 15: Select the tuner mode.

Step 16: Start "Channel Scan".

Step 17: Read to accept the end user license agreement.

Step 18: Install your apps.

Step 19: Start exploring your Google TV.

Note:

1) Settings in initial setup may vary depending on the region or model.

2) Settings in initial setup may change without notice, which depends on Google requirements. You need to finish all settings according to what is indicated on the screen.

3) If you want to restart the initial setup after the first time, please select <DASHBOARD (⚙) button → Settings (⊕) → System → About → Reset>

User Settings

Source Menu

Press **SOURCE** () button to access the Source Menu as shown in the right picture.

- **Source:** Change the input source.
- **Shortcuts:** Setup to use each shortcut function.
- **Recent:** Show the list of recently-used applications.

Note:

- 1) The picture is only for reference.
- 2) Items in Source Menu may vary depending on the region, model or input source.



TV Menu

In TV mode, press **SOURCE** () button to access the source menu, then press **UP/DOWN/LEFT/RIGHT** and **OK** buttons to select and access the TV Menu as shown in the right pictures.

• Channels

Press **UP** button to select Channels menu.

- * **Programme Guide:** Access the electronic program guide in DTV mode.
- * **Channels:** Search for available TV channels.
- * **Channel Management:** Manage the channels.

• TV Options

- * **Source:** Open the source list.
- * **Picture:** Access the picture menu.
- * **Screen:** Select the screen mode.
- * **Sound:** Access the sound menu.
- * **Power:** Setup power options to turn off the TV or only the picture automatically.
- * **Parental Controls:** Setup for the parental lock system.
- * **CI Card:** Enable the user to select from the CAM-provided menu.
- * **Advanced Options:** Setup the advanced channel options.
- * **Settings:** Access main menu settings.

• Record

Press **DOWN** button to select Record menu.

- * **Device Info:** Show the detailed information of the connected USB storage device, and setup for the best usage of Time-shift function.
- * **Time Shift Mode:** Enable or disable the Time-shift function.

Note:

- 1) The pictures are only for reference.
- 2) Settings in TV Menu may vary depending on the region, model or input source.

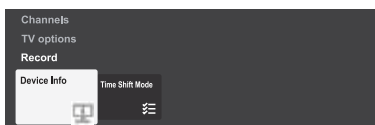
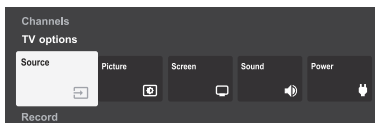
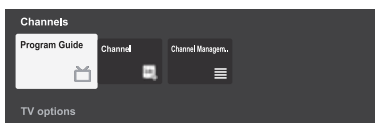

User Settings

Dashboard Menu

Press **DASHBOARD** (⚙️) button to access the Dashboard Menu as shown in the right picture.

- 1. Date & Time:** Show the date and time.
- 2. Settings:** Access main menu settings.
- 3. Account Center:** Add other family members' Google accounts, or setup and manage each Google account on your Google TV.
- 4. Screensaver:** Open the screensaver mode.
- 5. Inputs:** Access the source list.
- 6. Picture:** Access the picture menu.
- 7. Sound:** Access the sound menu.
- 8. Wi-Fi:** Connect the TV to the network.
- 9. Accessibility:** Start the accessibility function to help the visually-impaired or hearing-impaired viewers understand and use the TV easily.
- 10. Notifications:** Show the detailed notifications or tips for the best usage of your Google TV.

Note:

- 1) The picture is only for reference.
- 2) Settings in Dashboard Menu may vary depending on the region, model or input source.

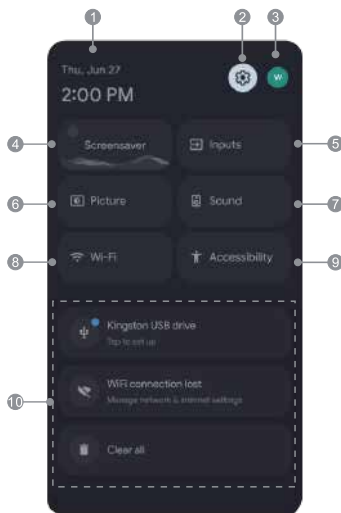

Main Menu

Step 1: In dashboard menu, select "Settings (⚙️)" to enter main menu settings as shown in the following pictures.

Step 2: Press **UP/DOWN** and **OK** buttons to select and enter a submenu.

Step 3: Press **UP/DOWN/LEFT/RIGHT** and **OK** buttons to select and adjust an item.

Step 4: Press **BACK** (←) button to back to the upper-level menu, or exit main menu settings.

Note:

- 1) The pictures are only for reference.
- 2) Settings in Main Menu may vary depending on the region, model or input source.

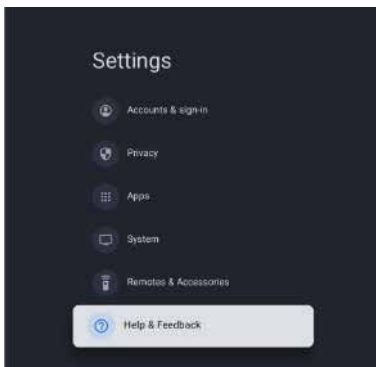
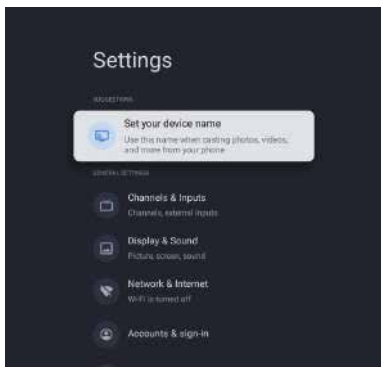

User Settings

SUGGESTIONS

Show the recommended or unfinished settings for the best usage of your Google TV.

GENERAL SETTINGS

Adjust settings related to your Google TV device and system.

Channels & Inputs

Search for available TV channels, or setup the input sources.

- **Channels:** Search for available TV channels.

*** Satellite Channel Tuning ***

To search for satellite channels in **Channels**, please refer to the following steps:

Step 1: Connect the satellite coaxial cable to the corresponding antenna port of the TV set.

Step 2: Turn on the TV and press **SOURCE** (☐) button to select "Satellite" as the input source in source list.

Step 3: Select < **DASHBOARD** (⚙) button → Settings (⊕) → Channels & Inputs → Channels → Satellite > to access the following interface of satellite tuning menu.

* **Channel Installation Mode:** Select the desired satellite channel installation mode between "Preferred Satellite" and "General Satellite".

* **Satellite Re-scan:** Search for satellite channels automatically.

* **Satellite Add:** Add a new satellite.

* **Satellite Update:** Search to update the satellite data.

* **Satellite Manual Tuning:** Search for satellite channels manually.

Note: Manual Tuning can be done only on the satellite used for automatic channels scan. If another satellite is selected inside manual tuning menu, please redo the automatic scan again from Channel menu then do manual tuning.

- **Inputs:** Setup the input sources.

- * Setup the standby or not-connected inputs.

- * Turn on or turn off the HDMI CEC link function to select whether or not to control the connected HDMI devices.

- * Select whether or not to turn off the connected HDMI devices when you turn off the TV.

- * Select whether or not to turn on the TV when you turn on the connected HDMI devices.

- * Show the HDMI EDID version.

- * Show the CEC device list.

Display & Sound

Adjust settings related to picture or sound quality.

- **Picture:** Adjust settings related to picture quality.

- * **Picture Mode:** Select the picture mode based on your viewing environment. Choices may vary depending on the input source.

- * **Backlight:** Adjust the backlight of the screen. It is available only when the "Auto Backlight" is turned off.

- * **Auto Backlight:** Turn on to automatically adjust the screen backlight depending on the input signal.

- * **Brightness:** Adjust the lightness of the picture.

- * **Contrast:** Adjust the difference between light and dark areas of the picture.

- * **Saturation:** Adjust the colorfulness of the color relative to its own brightness.

- * **HUE:** Adjust the color tint of the picture.

- * **Sharpness:** Adjust the edge of the picture.

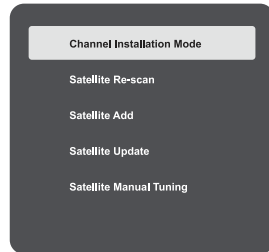

Note: The picture is only for reference.

User Settings

- * **Advanced Settings:** Adjust advanced picture settings. Choices may vary depending on the region, model or input source.
 - **Color Temperature:** Adjust the overall color tone of the picture.
 - **DNR:** Remove the noise from the picture signal.
 - **MPEG NR:** Reduce the noise created while compressing or converting the MPEG signal.
 - **Max Vivid:** Turn on or turn off the Max Vivid mode.
 - **Adaptive Luma Control:** Adjust the luma of the picture automatically depending on the input signal.
 - **Local Contrast Control:** Control local contrast.
 - **Dynamic Color Booster:** Select the effect of dynamic color booster.
 - **Flesh Tone:** Setup the flesh tone.
 - **DI Film mode:** Suppress the image jitter to achieve a stable and fluent play of the dynamic pictures.
 - **Blue Stretch:** Turn on or turn off the Blue Stretch function.
 - **Gamma:** Adjust the light intensity of original image.
 - **Game Mode:** It is automatically turned on when the picture mode is "Game".
 - **ALLM:** Turn on or turn off ALLM mode.
 - **PC Mode:** Turn on or turn off PC mode.
 - **HDMI RGB Range:** Setup the HDMI RGB range.
 - **Eye Protection Mode:** Select the effect of eye protection mode.
 - **Color Space:** Turn on or turn off color space.
 - **Color Tuner:** Adjust the detailed color parameters.
 - **11 Point White Balance Correction:** Adjust the detailed parameters of white balance correction.
- * **Reset to Default:** Restore all user settings in picture menu to the default values.

- **Screen:** Select the screen mode.

- **Sound:** Adjust settings related to sound quality.
 - * **Sound Style:** Select the sound mode based on your viewing requirements. Choices may vary depending on the input source.
 - * **Balance:** Control the sound balance between left and right speakers.
 - * **Bass:** Adjust the low frequency of the sound.
 - * **Treble:** Adjust the high frequency of the sound.
 - * **Sound Surround:** Turn on or turn off the surround sound system.
 - * **Equalizer Detail:** Adjust the equalizer frequencies in details. It is available only when you have selected "User" mode in "Sound Style".
 - * **Auto Volume Control:** Turn on to automatically adjust the sound volume depending on the input source.
 - * **Downmix Mode:** Select the downmix mode between "Stereo" and "Surround".
 - * **Dialogue Enhancer:** Select the effect of dialogue enhancer.
 - * **Reset to Default:** Restore all user settings in sound menu to the default values.

- **Audio Output:** Select the mode of digital audio output, or adjust the value of digital audio delay.

- **Network & Internet**
 - * Connect the TV to the wired or wireless network.
 - * Adjust settings related to the network configuration.
 - * Setup WOW/WOL/WOC function to turn on the TV from standby mode by your mobile device through network connection.

User Settings

■ Accounts & Sign In

- * Sign in to your Google account for new apps, recommendations, movies and more from Google.
- * Add other family members' Google accounts.
- * Setup and Manage each Google account on your Google TV.

■ Privacy

Adjust privacy-related settings including device settings, account settings and app settings.

■ Apps

- * Show the list of recently-opened, installed or system applications.
- * Setup app permissions to use specific functions.
- * Setup special app access to make the best usage of applications.
- * Setup restrictions on app installation from unknown sources.

■ System

- * Show basic device information.
- * Adjust settings related to the system and features of your Google TV.
- * Restart the TV, or restart the initial setup.

■ Remotes & Accessories

Connect the Bluetooth remote control or other Bluetooth devices. Before Bluetooth searching, please make sure that you have turned on the pairing mode of external Bluetooth devices. For the remote control supplied with the TV, please press and hold **BACK** (←) and **HOME** (🏠) buttons simultaneously to open its pairing mode. For other Bluetooth devices, please read their own instruction manual for opening the pairing mode.

Note: The Bluetooth remote control can be paired with the TV easily and quickly by just pressing Google Assistant (🗣️) button on any interface.

■ Help & Feedback

- * Send product feedback for Google's help.
- * Show the official website of Google TV Help.

Media Player

Media Operation

You can play video, audio and image files on the TV from your USB storage devices.

Step 1. Connect your USB storage device to the USB input terminal.

Step 2. Press **HOME** (🏠) button to enter the home screen.

Step 3. Press **UP/DOWN/LEFT/RIGHT** and **OK** buttons to select and enter "Multimedia Player" in the list of "Your apps".

Step 4. Press **UP/DOWN/LEFT/RIGHT** and **OK** buttons to select the desired USB storage device

Step 5. Press **UP/DOWN/LEFT/RIGHT** and **OK** buttons to select the desired media file.

Step 6. Press **OK** button to start the playback.

Step 7. Press **BACK** (←) button to exit the playback.

Gentle Reminder When Using the Media Player

- 1). Some USB storage devices may not be compatible to operate smoothly with this TV.
- 2). Back up all of the data in the USB storage device in case data was lost due to an unexpected accident. We do not assume any liability for the losses by misuse or malfunction. Data backup is consumer's responsibility.
- 3). For large file sizes, the loading time may be slightly longer.
- 4). The recognition speed of a USB storage device may depend on each device.
- 5). When connecting or disconnecting the USB storage device, ensure that the TV is not in USB mode otherwise the USB storage device or the files stored in it may be damaged.
- 6). Please use only a USB storage device which is formatted in FAT16, FAT32 or NTFS file system provided with the Windows operating system. In case of a storage device formatted as a different utility programme which is not supported by Windows, it may not be recognized.
- 7). When using a USB hard disk which requires electric power source, ensure its rated current does not exceed the current marked at the USB terminal. If the rated current of the USB hard Disk exceeds the marked current, the TV may be changed to standby mode or there may be some other problems, you should pull away the USB hard disk and restart the TV system.
- 8). An "Not support" message will be displayed if the file format is unsupported or corrupted.
- 9). FHD big picture needs longer time to process, which is not caused by the TV. Please be patient to wait.
- 10). This TV may not support some multimedia files changed and upgraded as the change of encoding format or other technical advances.

Media Player

Watch Movies

While watching a movie, press the following buttons to control the movie playback.

Button	Function
OK	Pause or play.
⚙️	Access the dashboard menu.
▲	Access movie menu settings.
▼	Show the movie playlist.
◀ or ▶	Fast backward or fast forward.

Play Music

While playing music, press the following buttons to control the music playback.

Button	Function
OK	Pause or play.
⚙️	Access the dashboard menu.
▲	Access music menu settings.
▼	Show the music playlist.
◀ or ▶	Short press to previous or next piece of music. Long press to fast backward or fast forward.

Browse Photos

While browsing a photo, press the following buttons to control the photo playback.

Button	Function
OK	Access photo menu settings.
⚙️	Access the dashboard menu.
▲ or ▼	Show the photo playlist.
◀ or ▶	Skip to previous or next photo.

Troubleshooting

Before calling a service technician, please check the following table for a possible cause of the symptom and some solutions.

■ General Problem / Solution

● Remote control does not work

- * Change the batteries.
- * Check if batteries are installed correctly.
- * Check if main power is connected.
- * Check if there are some items between remote sensor and remote control.

● Poor Signal

- * This is usually caused by interference from electronic equipments or radio interference sources.

■ Picture & Sound / Solution

● No picture, no sound

- * Check the signal source.
- * Plug another electrical device into the outlet to check if it is working or turned on.
- * Check if the power plug is in good contact with the outlet.

● No sound, picture OK

- * If no sound, unmute the sound or increase the sound volume.
- * Open the sound menu and adjust "Balance".

● Abnormal picture

- * For no color or bad picture quality, you may:
 1. Adjust the color option in picture menu settings.
 2. Keep the TV at a sufficient distance from other electronic devices.
 3. Try another channel.
- * Bad TV signal (Display mosaic or snowflakes)
 1. Check the signal cable and adjust the antenna.
 2. Fine tune the channel.
 3. Try another channel.

■ Multimedia Player / Solution

● "This file is invalid" / "Unsupported audio" appears, or audio is normal but video is abnormal, or video is normal but audio is abnormal.

- * The media file may be damaged, check if the file can be played on the PC.
- * Check if video and audio codec is supported.

■ Network / Solution (May not be available)

● Network failure

- * Check if the router works well.
- * Make sure the TV has been connected to the router successfully.

■ Browser / Solution (May not be available)

● Web page can not be displayed completely

- * Some third-party extensions of the current web page may not be supported, and please close the current web page.

● Browser is forced to be shut down

- * The current web page may include too many contents which cause there isn't sufficient memory and the browser is closed.

● Casting from smart phones:

- Check if TV and the smart phone are connected to the same wireless network.
- Check if Google casting application is used .
- Some smart phones may not work properly or be not supported.

Specifications

Note: Specifications may vary depending on the region or model.

Item	Model	2T-C32GH3000X	
LCD panel		80 cm	
Resolution		1,049,088 pixels (1366 x 768)	
Video colour system		PAL/SECAM/NTSC 3.58/NTSC 4.43/PAL 60	
TV function	TV-standard	Analogue	PAL: B/G, D/K, I SECAM: B/G, D/K, K/K1 NTSC: M
		Digital	DVB-T / DVB-T2 (for Asia only)
	Receiving channel	VHF/UHF	44.25 - 863.25 MHz
	TV-tuning system		Auto Preset
	STEREO/BILINGUAL		NICAM: B/G, I, D/K A2 stereo: B/G MTS:M
Audio amplifier		Total 16W (8W x 2)	
Terminals	ANTENNA IN	75Ω DIN type	
	HDMI 1	HDMI	
	HDMI 2	HDMI, ARC	
	USB1	USB 2.0 (DC5V 500mA output)	
	USB2	USB 2.0 (DC5V 500mA output)	
	LAN	Network connector (10/100 BASE-T)	
	EARPHONE	Earphone connector	
	DIGITAL AUDIO OUT	Optical S/PDIF digital audio output	
AV IN	Audio and video input		
Wi-Fi Protocol		IEEE 802.11 a/b/g/n/ac 2T/2R Dual Band	
Wi-Fi Security		WPA3-Personal, WPA2-Personal, WPA-Personal	
Bluetooth		V2.1 + EDR / 4.2 / 5.1	
OSD language		English/Afrikaans/Bosnian/Czech/Danish/German/Estonian/Spanish/French/Croatia/Indonesian/Italian/Swahili/Latvian/Lithuanian/Hungarian/Malaysian/Netherlands/Norwegian/Polish/Portuguese/Romanian/Albanian/Slovak/Slovenian/Finnish/Swedish/Vietnamese/Turkish/Greek/Serbian/Lithuanian/Macedonian/Mongolian/Russian/Ukrainian/Georgian/Hebrew/Arabic/Persian/Amharic/Hindi/Tamil/Thai/Burmese/Korean/Simplified Chinese/Traditional Chinese/Japanese	
Power requirement		AC 100 - 240V, 50/60 Hz	
Power consumption (Standby)		60W (0.5W)	
Dimensions	without stand W x H x D (mm)	716 X 426 X 83	
	with stand W x H x D (mm)	716 x 466 x 178	
Weight without stand (with stand)		3.3 kg (3.4 kg)	
Operating temperature		0°C to + 40°C	

Specifications

Note: Specifications may vary depending on the region or model.

Item	Model	2T-C43GH3000X	
LCD panel		109 cm	
Resolution		2,073,600 pixels (1920 x 1080)	
Video colour system		PAL/SECAM/NTSC 3.58/NTSC 4.43/PAL 60	
TV function	TV-standard	Analogue	PAL: B/G, D/K, I SECAM: B/G, D/K, K/K1 NTSC: M
		Digital	DVB-T / DVB-T2 (for Asia only)
	Receiving channel	VHF/UHF	44.25 - 863.25 MHz
	TV-tuning system		Auto Preset
	STEREO/BILINGUAL		NICAM: B/G, I, D/K A2 stereo: B/G MTS:M
Audio amplifier		Total 16W (8W x 2)	
Terminals	ANTENNA IN		75Ω DIN type
	HDMI 1		HDMI
	HDMI 2		HDMI, ARC
	USB1		USB 2.0 (DC5V 500mA output)
	USB2		USB 2.0 (DC5V 500mA output)
	LAN		Network connector (10/100 BASE-T)
	EARPHONE		Earphone connector
	DIGITAL AUDIO OUT		Optical S/PDIF digital audio output
AV IN		Audio and video input	
Wi-Fi Protocol		IEEE 802.11 a/b/g/n/ac 2T/2R Dual Band	
Wi-Fi Security		WPA3-Personal, WPA2-Personal, WPA-Personal	
Bluetooth		V2.1 + EDR / 4.2 / 5.1	
OSD language		English/Afrikaans/Bosnian/Czech/Danish/German/Estonian/ Spanish/French/Croatia/Indonesian/Italian/Swahili/Latvian/ Lithuanian/Hungarian/Malaysian/Nederlands/Norwegian/Polish/ Portuguese/Romanian/Albanian/Slovak/Slovenian/Finnish/ Swedish/Vietnamese/Turkish/Greek/Serbian/Lithuanian/ Macedonian/Mongolian/Russian/Ukrainian/Georgian/Hebrew/ Arabic/Persian/Amharic/Hindi/Tamil/Thai/Burmese/Korean/ Simplified Chinese/Traditional Chinese/Japanese	
Power requirement		AC 100 - 240V, 50/60 Hz	
Power consumption (Standby)		74W (0.5W)	
Dimensions	without stand W x H x D (mm)		955 X 559 X 84
	with stand W x H x D (mm)		955 x 603 x 212
Weight without stand (with stand)		5.5 kg (5.6 kg)	
Operating temperature		0°C to + 40°C	

Licenses



Google TV is the name of this device's software experience and a trademark of Google LLC. Google, YouTube, Google Cast and YouTube Music are trademarks of Google LLC.



The terms HDMI, HDMI High-Definition Multimedia Interface, HDMI Trade dress and the HDMI Logos are trademarks or registered trademarks of HDMI Licensing Administrator, Inc.



Manufactured under license from Dolby Laboratories. Dolby, Dolby Audio, and the double-D symbol are trademarks of Dolby Laboratories Licensing Corporation.

End User License Agreement

1. General

Please read this agreement carefully before using this TV. Using this TV indicates your acceptance of this agreement. We reserve all rights not expressly granted to you in this End User License Agreement.

The End User License Agreement ("EULA") is a legal agreement between you (user of this TV) and us (the TV manufacturer) for the TV software, owned by us, third-party providers or third-party licensors. The TV software includes software for this TV, including updated or modified software, provided by us or third parties, whether stored on media or downloaded to this TV via any method, but not open source software.

2. Software License

You can't use the TV software except specified herein. We and third-party licensors grant you a limited license to use the TV software only on this TV. The TV software may create data files automatically and you agree that any such data files should be deemed as a part of the TV software. The TV software is licensed as a single product, and you should not separate its component parts for use on other devices unless expressly authorized by us. The software of a third party may be accompanied by a separate license, in which case you agree that such third-party license will govern your use of such third-party software.

You agree not to modify, reverse engineer, decompile or disassemble the TV software in whole or in part, or to use the TV software in whole or in part for any purpose other than allowed under this EULA. In addition, you should not TV software. You shall not (1) bypass, modify, defeat or circumvent any of the functions or protections of the TV software or any mechanisms operatively linked the TV software; or (2) remove, alter, cover or deface any trademark or notices on the TV software. We and third-party licensors retain all rights that this EULA does not expressly grant to you.

This TV contains open source software which is subject to open source licenses. Some GPL executables and LGPL / MPL libraries used in this TV are subject to the GPL2.0/LGPL2.1/MPL1.1 License Agreements. We hereby offer to deliver, upon request, a copy of the complete corresponding source code for the copyrighted open source software packages used in this TV for which such offer is requested by the respective licenses. This offer is valid for a period of three (3) years from the date the distribution of this TV by us. To obtain the source code, please contact our service center.

3. Software Updates or Modifications

We, or third parties may update or modify the software from time to time, for example, but not limited to, for the purposes of error correction, improvement of features and enhancement of security features. Such updates or modifications may change or delete the nature of features or other aspects of the TV software, including features you may rely on.

The updated or modified software will be provided to you by us or third parties through the network or other methods. And you may have the right to decide whether or not to accept or install such updates or modifications according to your actual need. Generally, as for updates or modifications provided by us, we recommend you to accept or install them for better use of this TV, and for some system-critical updates or modifications provided by us, which may decide whether or not this TV can be used normally and continuously, we may automatically download and install such updates or modifications in this TV without asking for your acceptance. As for updates or modifications provided by third parties, you decide completely at your own discretion, risk or liability. Please do not turn off this TV during software updating, otherwise it may cause serious problems for which you should be responsible by yourself.

4. Network - Based Services and Contents

This TV has the smart feature which provides access to selected application services (the services) from third - party providers. The smart feature requires a network connection. Your ability to access the services, and the quality of the services presented, are subject to your network provider 's service and terms as well as the network speed you use.

The contents, including but not limited to data, music, sound, audio, images, graphics, likenesses, software, text, video, messages, tags or other materials, provided by third-party providers, and the availability of the services are at the sole discretion and under the control of third-party providers. The contents and the services of each third - party provider are provided pursuant to the terms and conditions of that third - party provider.

The services and the contents are only used for your own personal, private viewing, and shall not be used for any viewing or exhibition for which (or in a venue in which) an access, or viewing fee is charged, or for any public

End User License Agreement

exhibition or viewing. The services and the contents are not available in all languages or in all countries or regions. Third parties make no representation that the services and the contents are appropriate or available for use in any particular location. To the extent you choose to use or access the services and the contents, you do at your own initiative and are responsible for compliance with any applicable laws, including but not limited to applicable local laws and privacy and data collection laws.

Some web pages or videos may not be supported due to network failure, difference of regions or service interruption, which has nothing to do with this TV. Some models may support apk installation by yourself, when using this feature, you should ensure the correctness, security, compatibility and legality of the apk and should be responsible for any obligations thus resulted in. Some models may support installing and using file manager application by yourself, when using this feature, you should not revise or delete a system file, otherwise it will cause function failure or data loss of this TV, and you should be responsible for any obligations thus resulted in obligations thus resulted in.

The services and the contents are controlled by third - party providers by means of network and transmission facilities, which are subject to alteration, suspension, removal, termination or interruption, or invalid access at any time without further notice in that the manufacturer is unable to control or to be informed of the aforesaid change. We make a further declaration that we disclaim any responsibility or liability arising from customer's failure to use the network application services and contents caused by, including but not limited to, failure of network connection or communication lines, technological updates, or the alteration, suspension, interruption, termination, disabling, or removal of any services or contents by the network application providers etc.

5. Content Rights

We are not responsible for the contents you may access as a part or via your use of the services that were created by or are owned by a third party. Any responsibility or liability for the contents shall remain solely with the creator, owner or licensor of such third - party content, and not with us.

You understand, acknowledge and agree that the contents are protected by the proprietary and intellectual property rights of the creator, owner or licensor of such third - party content. You must not modify, reverse - engineer, copy, rent, lease, loan, sell, resell, re-transmit, distribute, trade, publicly display or create derivative works of any third-party content, either in whole or in part, without obtaining a license from the creator, owner or licensor.

The content creator, owner or licensor may use Microsoft PlayReady content access technology ("PlayReady") to protect their intellectual property, including copyrighted content. This TV uses PlayReady technology to access PlayReady-protected Content and/or WMDRM-protected Content ("WMDRM" means Microsoft Window Media digital rights management technology). If this TV fails to properly enforce restrictions on Content usage, the content creator, owner or licensor may require Microsoft Corporation ("Microsoft") to revoke this TV's ability to consume PlayReady-protected Content. Revocation should not affect unprotected Content or Content protected by other content access technologies. The content creator, owner or licensor may require you to upgrade PlayReady to access their Content. If you decline an upgrade, you will not be able to access content that requires the upgrade.

The content creator, owner or licensor may use Widevine DRM content access technology to protect their intellectual property, including copyrighted content. This TV uses Widevine DRM technology to access Widevine DRM-protected Content. If this TV fails to properly enforce restrictions on Content usage, the content creator, owner or licensor may require Widevine Technologies (a company) to revoke this TV's ability to consume Widevine DRM-protected Content. Revocation should not affect unprotected Content or Content protected by other content access technologies. The content creator, owner or licensor may require you to upgrade Widevine DRM to access their Content. If you decline an upgrade, you will not be able to access content that requires the upgrade.

6. Use by Minors

If you are a parent or guardian permitting a person under the legal age of majority ("Minor") to use the services or the contents, you agree to: (1) supervise the Minor's use of the services or the contents, including receipt and transmission of information and materials via the services, and the transactions made for digital goods, the services and the contents. (3) assume any liability resulting from the Minor's use of the services and the contents. (4) be bound by this EULA for the Minor's access and use of the services and the contents.

7. Privacy Policy

We don't collect or use any personal information by this TV. However, when you access the applications provided by third-party providers over which we have no control, third parties may collect or receive certain information

End User License Agreement

through the use of Cookies or other similar technologies. We are not responsible for the security or privacy of any information collected by third parties. You should exercise caution and review the privacy statements applicable to the third-party services you use.

For example, but not limited to, when you watch a video or access the services or contents provided by a third-party provider. That provider may collect or receive information about this TV (its IP address, device identifies, etc.), the requested transaction (your request to buy or rent the video), your use of the services and contents, and so on.

To allow you to access, browse or use the services and the contents, third parties may require you to establish a user account for which you must provide them with your true, accurate, current and complete information about yourself. You are responsible for maintaining the confidentiality of any or all of your passwords associated with any such account.

Third parties may charge fees for access to their contents or services, and in no event will you be charged for access to any portion or all of the contents and services unless the third-party provider obtains your prior agreement to pay such charges. If you don't consent to such charges, you may not have access to paid contents or services for which such charges apply.

When you use the TV software or access the services, third parties may collect data from, control, and/or monitor this TV, or other devices running or interacting with this TV. We are not responsible and liable for any activities between you and third parties.

8. Disclaimer of Warranty

THE TV SOFTWARE, THE SERVICES AND THE CONTENTS ARE PROVIDED TO YOU "AS IS" AND "AS AVAILABLE" AND WITHOUT WARRANTIES OF ANY KIND. WE, THIRD-PARTY PROVIDERS AND THIRD-PARTY LICENSORS DISCLAIM ALL WARRANTIES AND CONDITIONS, EXPRESS OR IMPLIED, INCLUDING BUT NOT LIMITED TO THE IMPLIED WARRANTIES OF NON-INFRINGEMENT, TITLE, MERCHANTABILITY, AND FITNESS FOR A PARTICULAR PURPOSE. WE, THIRD-PARTY PROVIDERS AND THIRD-PARTY LICENSORS DO NOT WARRANT THAT THE TV SOFTWARE, THE SERVICES OR THE CONTENTS WILL MEET YOUR REQUIREMENTS, OR THAT THE OPERATION OF THE TV SOFTWARE THE SERVICES OR THE CONTENTS WILL BE UNINTERRUPTED OR ERROR FREE. FURTHERMORE, WE, THIRD-PARTY PROVIDERS AND THIRD-PARTY LICENSORS DO NOT WARRANT OR MAKE ANY REPRESENTATIONS OR CONDITIONS REGARDING THE USE OR THE RESULTS OF THE USE OF THE TV SOFTWARE, THE SERVICES OR THE CONTENTS IN TERMS OF THEIR CORRECTNESS, ACCURACY, RELIABILITY OR OTHERWISE. NO ORAL OR WRITTEN INFORMATION OR ADVICE GIVEN BY US SHALL CREATE A WARRANTY OR CONDITION, OR IN ANY WAY CHANGE THIS DISCLAIMER OF WARRANTY AND CONDITION. SHOULD THE TV SOFTWARE, MEDIA ON WHICH THE TV SOFTWARE IS FURNISHED, THE SERVICES OR THE CONTENTS PROVE DEFECTIVE, YOU ASSUME THE ENTIRE COST OF ALL NECESSARY SERVING, REPAIR OR CORRECTION.

YOU UNDERSTAND, ACKNOWLEDGE, AND AGREE THAT THE SERVICES CONTENTS AND RELATED SOFTWARES ARE PROVIDED BY THIRD-PARTY PROVIDERS OVER WHICH WE HAVE NO CONTROL. THE SELECTION, PROVISION, QUALITY, PICTURE SIZE AND AVAILABILITY OF SUCH CONTENTS OR SOFTWARE ARE THE SOLE RESPONSIBILITY OF SUCH THIRD-PARTY PROVIDER OR OTHER THIRD-PARTY PROVIDERS. YOU AGREE TO COMPLY WITH ANY AND ALL TERMS AND CONDITIONS THAT THE THIRD-PARTY MAY SET FOR ITS SERVICES, CONTENTS AND SOFTWARE. YOU UNDERSTAND, ACKNOWLEDGE, AND AGREE THAT ANY CONTENTS OR SOFTWARE DOWNLOADED OR OTHERWISE OBTAINED THROUGH USE OF THE SERVICES IS DONE AT YOUR OWN DISCRETION AND RISK, AND YOU SHOULD BE SOLELY RESPONSIBLE FOR ANY CONSEQUENCES THAT RESULTS, INCLUDING ANY DAMAGE OR HARM CAUSED BY ANY VIRUS, SPYWARE, WORM OR MALWARE.

9. Limitation of Liability

TO THE EXTENT PERMITTED BY APPLICABLE LAW, WE SHALL NOT BE LIABLE TO YOU, WHETHER IN CONTRACT, TORT (INCLUDING NEGLIGENCE), OR ANY THEORY OF LIABILITY, AN WHETHER OR NOT THAT THE POSSIBILITY OF SUCH DAMAGES OR LOSSES HAS BEEN NOTIFIED TO US, FOR THE FOLLOWING CIRCUMSTANCES:

- (1). ANY INDIRECT, INCIDENTAL, SPECIAL, PUNITIVE OR CONSEQUENTIAL DAMAGES.
- (2). ANY LOSS OF INCOME, BUSINESS, ACTUAL OR ANTICIPATED PROFITS, OPPORTUNITY, GOODWILL, OR REPUTATION (WHETHER DIRECT OR INDIRECT).
- (3). ANY DAMAGE TO OR CORRUPTION OF DATA (WHETHER DIRECT OR INDIRECT).
- (4). ANY LOSS OR DAMAGE AS A RESULT OF:
 - (A) USE YOU MAKE OF THE SERVICES.
 - (B) ANY RELIANCE PLACED BY YOU ON THE COMPLETENESS, ACCURACY OR EXISTENCE OF ANY ADVERTISING.
 - (C) ANY RELATIONSHIP OR TRANSACTION BETWEEN YOU AND AN THIRD-PARTY PROVIDER OF ANY SERVICE OR

End User License Agreement

CONTENT, INCLUDING ADVERTISERS AND SPONSORS WHOSE ADVERTISING IS MADE AVAILABLE ON OR VIA THE SERVICES.

(D) ANY CHANGES TO THE SERVICES, OR ANY PERMANENT OR TEMPORARY CESSATION IN THE PROVISION OF THE SERVICES OR ANY PORTION THEREOF .

10. Dispute Resolution

If a dispute, controversy or difference arising in any way from this EULA or your use of the TV software is not amicably settled, it shall be subject to the non-exclusive jurisdiction of the courts of the jurisdiction where you are a resident. Notwithstanding the foregoing, we may apply for injunctive remedies (or an equivalent type of urgent legal relief) that we deem necessary or appropriate in any jurisdiction.

11. Applicable Law and Severability

This EULA is governed by the laws of the jurisdiction where you are a resident, without regard to its conflict of law provisions. If any provision of this EULA is held to be void, invalid, unenforceable or illegal, the other provisions shall remain in full force and effect.

12. Termination

This EULA is effective until terminated. Your rights under this EULA will terminate automatically or otherwise cease to be effective without notice from us if you fail to comply with any items of this EULA. Upon termination of this EULA, you shall cease all use of the TV software, and you will have no recourse against us, third-party licensors or third-party providers.

13. Entire Agreement and Governing Language

This EULA is the entire agreement between you and us relating to the TV software and supersedes all prior or contemporaneous oral or written communications, proposals and representations with respect to the TV software or any other subject matter covered by this EULA. Any translation of this EULA is provided only for your convenience or local requirements. The English version of this EULA shall govern in the event of contradiction or dispute between English and any non-English versions .

SHARP

SHARP CORPORATION